Preface

- Thank you for purchasing our product.
- This manual is about the various functions of the product, wiring methods, setting methods, operating methods, troubleshooting methods, etc.
- Please read this manual carefully before operation, use this product correctly to avoid unnecessary losses due to incorrect operation.
- After you finish reading, please keep it in a place where it can be easily accessed at any time for reference during operation.

Note

- Modification of this manual's contents will not be notified as a result of some factors, such as function upgrading.
- We try our best to guarantee that the manual content is accurate, if you find something wrong or incorrect, please contact us.
- The content of this manual is strictly prohibited from reprinting or copying.
- This product is not allowed to be used in explosion-proof situations.

Version

U-SUP-7017-EN1

Safety Precautions

In order to use this product safely, be sure to follow the safety precautions described.

About this manual

- Please submit this manual to the operator for reading.
- Please read the operation manual carefully before applying the instrument. On the precondition of full understanding.
- This manual only describes the functions of the product. The company does not guarantee that the product will be suitable for a particular use by the user.

Precautions for protection, safety and modification of this product

- To ensure safe use of this product and the systems it controls, Please read carefully the operation manual and understand the correct application methods before putting into operation, to avoid unnecessary losses due to operation mistakes. If the instrument is operated in other ways not described in the manual, the protections that the instrument give may be destroyed, and the failures and accidents incurred due to violation of precautions shall not be borne by our company.
- When installing lightning protection devices for this product and its control system, or designing and installing separate safety protection circuits for this product and its control system, it needs to be implemented by other devices.
- If you need to replace parts of the product, please use the model specifications specified by the company.
- This product is not intended for use in systems that are directly related to personal safety. Such as nuclear power equipment, equipment using radioactivity, railway systems, aviation equipment, marine equipment, aviation equipment and medical equipment. If applied, it is the responsibility

of the user to use additional equipment or systems to ensure personal safety.

- Do not modify this product. The following safety signs are used in this manual:



Hazard, if not taken with appropriate precautions, will result in serious personal injury, product damage or major property damage.



Warning: Pay special attention to the important information linked to product or particular part in the operation manual.



- Confirm if the supply voltage is consistent with the rated voltage before operation.
- Do not use the instrument in a flammable and combustible or steam area.
- To prevent from electric shock, operation mistake, a good grounding protection must be made.
- Thunder prevention engineering facilities must be well managed: the shared grounding network shall be grounded at is-electric level, shielded, wires shall be located rationally, SPD surge protector shall be applied properly.
- Some inner parts may carry high voltage. Do not open the square panel in the front except our company personnel or maintenance personnel acknowledged by our company, to avoid electric shock.
- Cut off electric powers before making any checks, to avoid electric shock.
- Check the condition of the terminal screws regularly. If it is loose, please tighten it before use.
- It is not allowed to disassemble, process, modify or repair the product without authorization, otherwise it may cause abnormal operation, electric shock or fire accident.
- Wipe the product with a dry cotton cloth. Do not use alcohol, benzene

or other organic solvents. Prevent all kinds of liquid from splashing on the product. If the product falls into the water, please cut off the power immediately, otherwise there will be leakage, electric shock or even a fire accident.

- Please check the grounding protection status regularly. Do not operate if you think that the protection measures such as grounding protection and fuses are not perfect.
- Ventilation holes on the product housing must be kept clear to avoid malfunctions due to high temperatures, abnormal operation, shortened life and fire.
- Please strictly follow the instructions in this manual, otherwise the product's protective device may be damaged.



- Do not use the instrument if it is found damaged or deformed at opening of package.
- Prevent dust, wire end, iron fines or other objects from entering the instrument during installation, otherwise, it will cause abnormal movement or failure.
- During operation, to modify configuration, signal output, startup, stop, operation safety shall be fully considered. Operation mistakes may lead to failure and even destruction of the instrument and controlled equipment.
- Each part of the instrument has a certain lifetime, which must be maintained and repaired on a regular basis for long-time use.
- The product shall be scrapped as industrial wastes, to prevent environment pollution.
- When not using this product, be sure to turn off the power switch.
- If you find smoke from the product, smell odor, abnormal noise, etc., please turn off the power switch immediately and contact the company in time.

Disclaimer

- The company does not make any guarantees for the terms outside the scope of this product warranty.
- This company is not responsible for damage to the instrument or loss of parts or unpredictable damage caused directly or indirectly by improper operation of the user.

Package contents

Serial number	Item Name	Quantity
1	Dissolved Oxygen sensor	1
2	Manual	1
3	Certificate	1

After opening the box, please confirm the package contents before starting the operation. If you find that the model and quantity are incorrect or there is physical damage in appearance, please contact us.

Content

Chapter 1 Introduction	- 1 -
Chapter 2 Parameters	- 2 -
Chapter 3 Installation	- 3 -
3.1 Installation of Sensor	- 3 -
3.1.1 Quick-Release Poolside Fixed installation	- 3 -
3.1.2 Classic Poolside Fixed installation	- 4 -
3.1.3 Railing type fixed installation	- 5 -
3.2 Connection of Sensor	- 5 -
Chapter 4 Interface and Operation	- 6 -
Chapter 5 Calibration	- 8 -
Chapter 6 Maintenance	- 11 -
6.2 Sensor damage inspection	- 11 -
6.3 Preservation of the sensor	- 11 -
Chapter 7 Warranty & After-sales Service	- 12 -
Chapter 8 Communication Protocol	- 13 -

Chapter 1 Introduction

Dissolved oxygen sensor uses fluorescence method to measure dissolved oxygen, the top of the sensor is covered with a layer of fluorescent substance, when the blue light from the sensor irradiates to the fluorescent substance, the fluorescent substance is excited to emit red light, because oxygen molecules can take away energy (burst quenching effect), so the time and intensity of the excited red light is inversely proportional to the concentration of oxygen molecules, and the concentration of dissolved oxygen in water can be calculated.

The product is commonly used in the online monitoring of DO in various processes such as regulating ponds, biochemical ponds and effluent of sewage treatment plants; online monitoring of DO in water treatment plants, surface water, water for various industrial processes, aquaculture and other industries. The appearance of the sensor is shown in Figure 1. The dimensions of the sensor are shown in Figure 2.

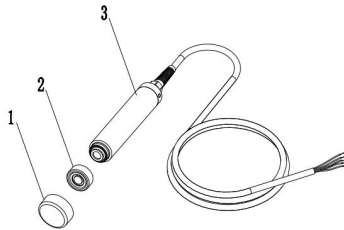

Figure 1: Appearance

1- Protective cap	2- Fluorescent cap
3- Sensor	

Note: When using the sensor, remove the protective cap (serial number 1) from the sensor. The fluorescent cap (serial number 2) is an important part of this sensor when measuring. Remember not to screw down the fluorescent cap (serial number 2).

The following figure shows the dimensions of the fluorescence dissolved oxygen sensor:

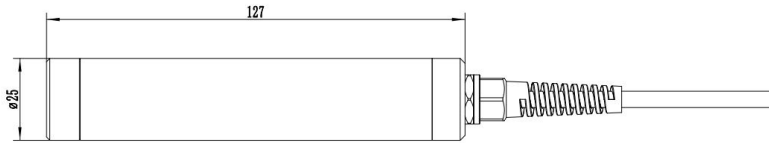

Figure 2: Dimension

Chapter 2 Parameters

Measurement	Dissolved Oxygen Sensor
Measure range	Dissolved Oxygen: 0.00 to 20.00 mg/L or 0~200% saturation Temperature: (0~45)°C
Accuracy	Dissolved Oxygen: $\pm 3\%/\pm 0.3$ mg/L(Take Larger one) Temperature: ± 0.5 °C
Repeatability	± 0.3 mg/L
Resolution	0.01mg/L
pressure	≤ 0.1 Mpa
Material	Stainless steel 316L
Power supply	(10-25) VDC
Signal interface	Modbus RS-485
Stocking temperature	-15°C to + 60°C
Operating temperature	0°C to 45°C (unfrozen)
Weight	0.3kg
Ingress protection	IP68/NEMA6P
Cable	10m (standard), 100m(optional)

Chapter 3 Installation

3.1 Installation of Sensor

3.1.1 Quick-Release Poolside Fixed installation

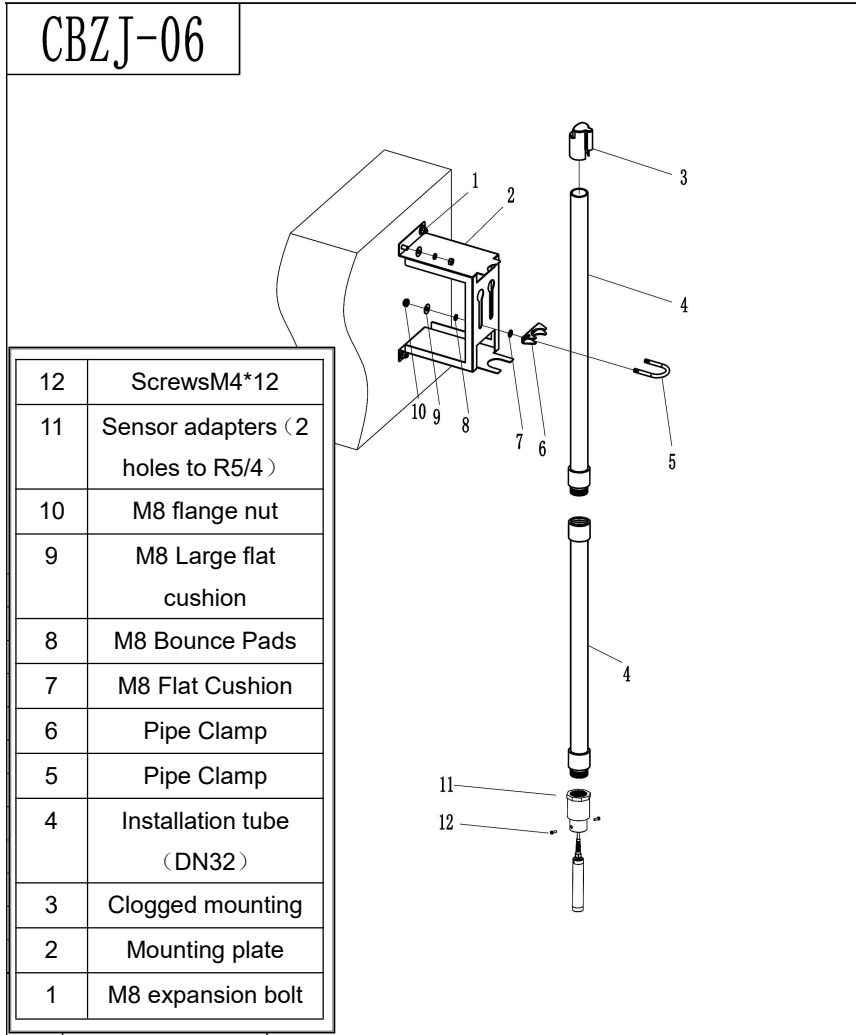

Note: The serial number 4 installation pipe DN32 on the figure represents the inner diameter of the pipe is 32mm.

3.1.2 Classic Poolside Fixed installation

CBJD-05

8	ScrewsM4*12
7	Sensor adapters (2 holes to R5/4)
6	M8 Flange nut
5	M8 socket head cap screw
4	Installation tube (DN32)
3	Clogged mounting
2	Installation of pipe clamps(Φ40)
1	expansion bolt

Note: The serial number 4 installation pipe DN32 on the figure represents the inner diameter of the pipe is 32mm.

3.1.3 Railing type fixed installation

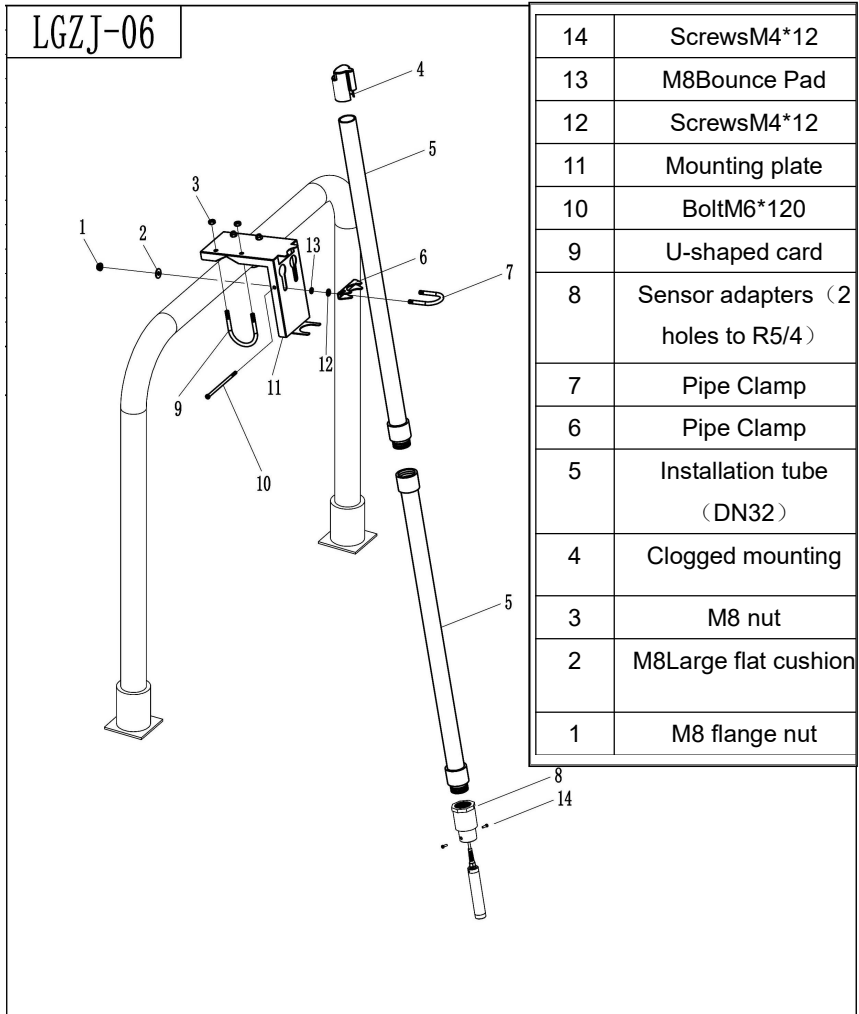

Note: The serial number 5 installation pipe DN32 on the figure represents the inner diameter of the pipe is 32mm.

3.2 Connection of Sensor

Sensors are properly connected according to the following wire core definitions:

Chart 2:

Wire number	1	2	3	4	5
Color	Brown	Black	Blue	White	Yellow+Green
Signal	+12VDC	AGND	RS485 A	RS485 B	Grounding wire

Chapter 4 Interface and Operation

4.1 Interface

The sensor is connected to the computer using RS485 to USB, and then the connection operation is performed using Modbus Poll.

Note: Modbus Poll software is universal software, which can be downloaded online by yourself.

4.2 Parameter Setting

(1) Click Setup on the top of the menu bar, select Read/Write Definition, then set the parameters (the first time the slave address is based on the slave label), enter "30" in the pop-up dialog box Quantity, and click OK.

Read/Write Definition

Slave ID:

Function: 03 Read Holding Registers (4x)

Address: Protocol address. E.g. 40011 -> 10

Quantity:

Scan Rate: [ms]

Disable

Read/Write Disabled

Disable on error

Read/Write Once

View

Rows

10 20 50 100 Fit to Quantity

Hide Alias Columns PLC Addresses (Base 1)

Address in Cell Enron/Daniel Mode

Note: When the slave address is changed, it will communicate with the new address, and the next time the slave is connected again, the address will be the recently changed address.

(2) Click Connection on the top of the menu bar, select the first line of Connection setup in the drop-down menu for setting (the initial baud rate is based on the slave label), and click OK.

Connection Setup

Connection
Serial Port

Serial Settings
Prolific USB-to-Serial Comm Port (COM4)
9600 Baud
8 Data bits
None Parity
1 Stop Bit
Advanced...

Mode
 RTU ASCII

Response Timeout
1000 [ms]

Delay Between Polls
1000 [ms]

Remote Modbus Server
IP Address or Node Name
127.0.0.1
Server Port
502
Connect Timeout
3000 [ms]
 IPv4
 IPv6

OK
Cancel

Note: Port is set according to the connected port number.

Tip: If the sensor has been connected according to the instructions and a Timeout Error appears at the software Display status indicating that it is not yet connected, remove and replace the USB connection port or check the USB to RS485 converter, etc. Repeat the above operation until the sensor is successfully connected.

Chapter 5 Calibration

The dissolved oxygen sensor has been calibrated at the factory, if you need to calibrate it yourself, you can follow the steps below.

5.1 Air calibration

(1) Clean and wipe the sensor, add a small amount of water (25mL~50mL) to the provided calibration bag and shake the bag a few times, then put the sensor into the calibration bag, but not in contact with the water, seal the calibration bag with your hand so that the sensor is in a more saturated air, the sensor should be protected from light and away from high temperature and hard objects during the calibration process. After the measurement data is stable, click on the 06 mark on the menu bar to bring up the box below. Enter 27 for Address, then 16 for Value and click Send.



Write Single Register

Slave ID: 10 Send

Address: 27 Cancel

Value: 16

Result
N/A
 Close dialog on "Response ok"

Use Function
 06: Write single register
 16: Write multiple registers

(2) After waiting for 20 seconds, change the Value to 19 and click Send.

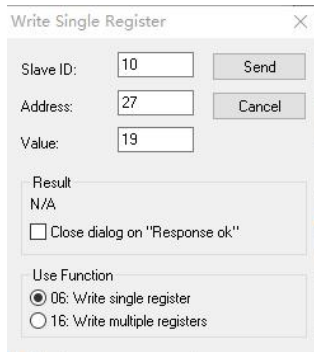

Write Single Register

Slave ID: 10 Send

Address: 27 Cancel

Value: 19

Result
N/A
 Close dialog on "Response ok"

Use Function
 06: Write single register
 16: Write multiple registers

5.2 Zero calibration

(1) Wipe the sensor dry, put it into anoxic water, wait for the measurement data to stabilize, click on the 06 mark on the menu bar, and the box below pops up. Enter 27 at Address, then enter 12 at Value and click Send.

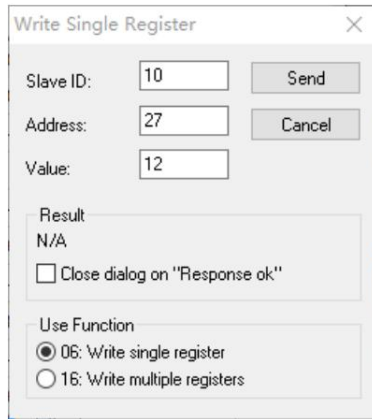

Write Single Register

Slave ID:

Address:

Value:

Result
N/A
 Close dialog on "Response ok"

Use Function
 06: Write single register
 16: Write multiple registers

(2) After waiting for 20 seconds, change the Value to 19 and click Send.

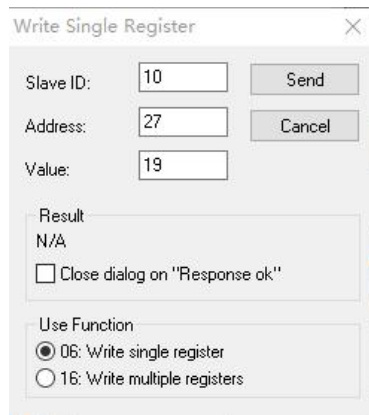

Write Single Register

Slave ID:

Address:

Value:

Result
N/A
 Close dialog on "Response ok"

Use Function
 06: Write single register
 16: Write multiple registers

5.3 Factory restoration calibration

Click on the 06 marker on the menu bar to bring up the box below. Enter 27 for Address, then 35 for Value and click Send to restore the slope to 1 and the deviation to 0.

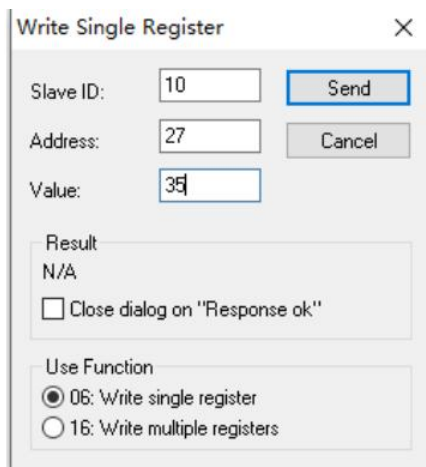

The image shows a dialog box titled "Write Single Register" with a close button (X) in the top right corner. It contains the following fields and controls:

- Slave ID: 10
- Address: 27
- Value: 35
- Buttons: Send (highlighted in blue), Cancel
- Result: N/A
- Checkbox: Close dialog on "Response ok"
- Use Function:
 - 06: Write single register
 - 16: Write multiple registers

Chapter 6 Maintainance

In order to get the best measurement results, regular maintenance and servicing are required. Maintenance and servicing mainly includes cleaning of the sensor, checking the sensor for damage, etc. The relevant status of the sensor can also be checked in the maintenance and inspection.

6.1 Sensor cleaning

It is recommended to clean the sensor at regular intervals (generally 3 months, depending on the site environment) to ensure the accuracy of the measurement. Clean the outer surface of the sensor with a stream of water, and if debris remains, wipe it with a damp, soft cloth. Do not place the sensor in direct sunlight or in a place where it can be illuminated by radiation. Exposure to sunlight for a total of one hour over the life of the sensor will cause the fluorescent cap to deteriorate, resulting in a faulty fluorescent cap that will display incorrect readings.

6.2 Sensor damage inspection

Check the appearance of the sensor, whether there is damage, if there is damage to contact the after-sales service center in a timely manner to replace, to prevent the sensor into the water because of damage to produce failure.

6.3 Preservation of the sensor

(1) When not in use, the product should be covered with its own protective cap, to avoid direct sunlight or exposure to the sun. To protect the sensor from freezing, store the DO probe in a place where freezing will not occur.

(2) Wash the probe before storing it for a long time. Avoid storing the device in a shipping box or in a plastic container with electric shock protection. Avoid touching and scratching the fluorescent cap with hands or other hard objects. The black substance on the outer layer of the fluorescent cap is the normal substance of the fluorescent cap and should not be scratched off.

(3) strictly prohibit the fluorescent cap is direct sunlight or exposure to the sun.

6.4 Fluorescent cap replacement

When the sensor's fluorescence cap is damaged, the fluorescence cap needs to be replaced. In order to ensure the accuracy of the measurement is recommended to replace the fluorescent cap once a year or when the fluorescent cap is more seriously damaged during routine inspection, the fluorescent cap needs to be replaced.

Steps to replace the fluorescent cap: screw the old fluorescent cap off the sensor and screw the new fluorescent cap on.

Note: When disassembling the fluorescent cap, pay attention to whether the seal is misaligned. If there is misalignment, reassemble.

Chapter 7 Warranty & After-sales Service

We promise to the customer that the hardware accessories provided during the supply of the instrument have no defects in material and manufacturing process. From the date of the purchase, if the user's notice of such defects is received during the warranty period, the company will unconditionally maintain or replace the defective products without charge, and all non customized products are guaranteed to be returned and replaced within 7 days.

Disclaimers:

- During the warranty period, product faults caused by the following reasons are not in the scope of Three Guarantees service
- Product faults caused by improper use by customers.
- Product faults caused by disassembling, repairing and refitting the product.

After-sales service commitment:

- We promise to deal with the customer's technical questions within 2 hours

- For the instruments returned to the factory for maintenance, we promise to issue the test results within 3 working days and the maintenance results within 7 working days after receiving them.

Chapter 8 Communication Protocol

The sensor is equipped with MODBUS RS485 communication function, please refer to this manual 3.2 for the wiring of communication. the specific MODBUS-RTU table is shown in the following table.

MODBUS-RTU	
Baud rate	4800/9600/19200/38400/57600
Data bits	8bit
Parity Check	Non

Register Name	Site	Type of Data	Number	Read/Write	Descriptions
Dissolved Oxygen Value	0	Float(Floating point type)	2	R (only read)	Units: mg/L
Dissolved oxygen saturation	2	Float	2	R	
Temp	4	Float	2	R	Units: °C
Slope	6	Float	2	W/R	Range: 0.5~1.5
Deviation value	8	Float	2	W/R	Range: -20~20

Salinity	10	Float	2	W/R	Range: g/Kg	
Atmospheric pressure	12	Float	2	W/R	Units: mmHg	
Baud rate	16	Float	2	R		
Slave Address	18	Float	2	R	Rang: 1~255	
Response Time	20	Float	2	R	Units: °C	
Modifying Baud rate	16	Signed (Shaping)	1	W	0-4800 1-9600 2-19200 3-38400 4-57600	
Modifying Slave Address	17	Signed (Shaping)	1	W	Rang: 1~255	
Modifying Response Time	30	Signed (Shaping)	1	W	2~60s (Multiples of 2)	
Air calibration	First	27	Signed (Shaping)	1	W	16
	Second	27	Signed (Shaping)	1	W	19
	If you have performed the first step and do not want to correct it, you should cancel it.					
	Cancel	27	Signed (Shaping)	1	W	21
Zero calibration	First	27	Signed (Shaping)	1	W	12
	Second	27	Signed (Shaping)	1	W	19
	If you have performed the first step and do not want to correct it, you should cancel it.					
	Cancel	27	Signed (Shaping)	1	W	21

Restore default	27	Signed (Shaping)	1	W	33: Reset response time (2s), salinity (0), atmospheric pressure (760)
Function Code	27	Signed (Shaping)	1	W	35: Reset slope 1, deviation value 0
R: 03 W: Writing shaped data as 06 Write floating point data as 16					

- 485 parsing:

Read Slope:

Register Name	Site	Data Type	Number	R/W	Descriptions
Slope	6	F	2	W/R	Range: 0.5~1.5

Send command: 01 03 00 06 00 02 24 0A

Device return: 01 03 04 00 00 40 E0 CA 7B

Sending command parsing.

01: Device address 01

03: The function code of reading register content 03

00 06: The starting register address to read is 0006

00 02: Read 2 registers

24 0A: CRC16 check code

Device return resolution.

01: Device address 01

03: Read register content function code 03

04: Returned data length 4 bytes

00 00 40 E0: the slope of the read is 7.00 (using the IEEE 754 method of parsing 40 E0 00 00)

CA 7B: CRC16 check digit

- Modify the slave address

Register Name	Site	Data Type	Number	R/W	Descriptions
Modify the slave address	17	Signed(Shaping)	1	W	Range: 1~255

Send command: 01 06 00 11 00 0F 99 CB

Device return: 01 06 00 11 00 0F 99 CB

Send command resolution.

01: Device address 01

06: Function code 06 for writing register contents

00 11: Write data register address 0017

00 0F: Write data content for 0015

99 CB: CRC16 check code

Device return resolution.

01: Device address 01

06: Function code 06 for writing register content

00 11: return to write data register address of 0017

00 0F: return to modify the content of the data as 0015

99 CB: CRC16 check digit

- Setting the Slope

Register Name	Site	Data Type	Number	R/W	Descriptions
Slope	6	Float	2	W/R	Range: 0.5~1.5

Send command: 01 10 00 06 00 02 04 00 00 3F 80 63 D5

Device return: 01 10 00 06 00 02 A1 C9

Sending command parsing.

01: Device address 01

10: Function code 16 for writing register contents

00 06: Start register address for writing data 0006

00 02: write 2 registers of data

04: Data length 4 bytes

00 00 3F 80: the slope of the write is: 1.00 (using IEEE 754 way to parse 3F 80 00 00)

63 D5: CRC16 check code

Device return parsing.

01: device address 01

10: Write the contents of the register function code 16

00 06: return the starting register address for writing data 0006

00 02: return 2 registers

A1 C9: CRC16 check digit